

GROVE®

GMK5120B



ALL TERRAIN HYDRAULIC CRANE



Dimensions

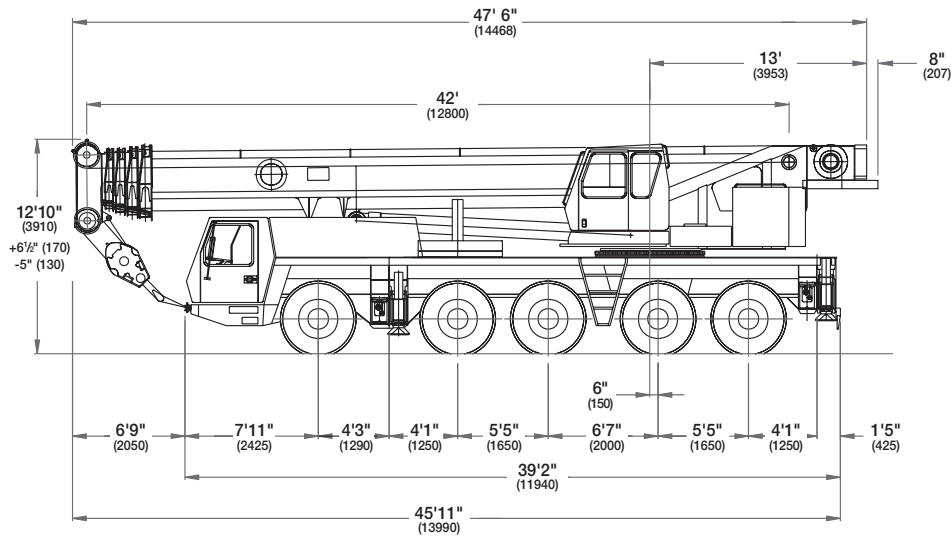
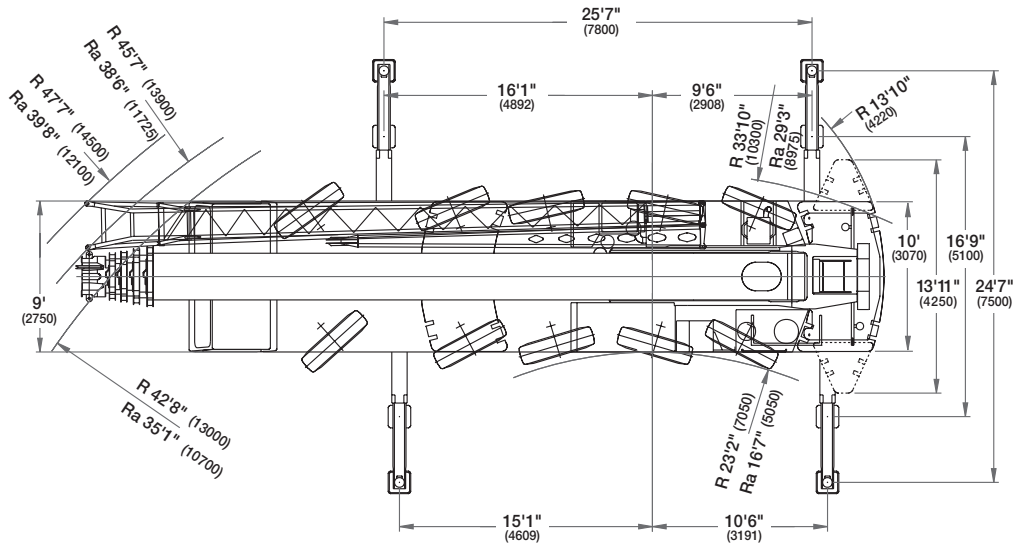

Note: () Reference dimensions in mm

BASIC WEIGHTS (LBS.)

Mercedes Power, 20.5 tires, auxiliary hoist, 2nd oil cooler, outrigger pads, hydraulic offsettable swingaway with hydraulic reel, 10 x 8 x 10, 3MT counterweight bolted to superstructure.

Additions:

	Axles 1 - 3	Axles 4 & 5	Total
Auxiliary boom nose	362	-207	155
20.5 Spare tire	-487	1,296	809
Driveline retarder	-64	716	652
*24,200 lbs. counterweight (15,400 lbs. on carrier)	14,660	970	15,630

REMOVAL:

*Substitute IPO counterweight in lieu of auxiliary hoist	93	-46	47
Substitute manually offsettable swingaway in lieu of hydraulic swingaway (hose reel removed)	-686	296	-390
Remove 3MT bolted counterweight from superstructure	3,384	-9,777	-6,393
10 x 6 x 10 drive	-772	-22	-794
16.00 tires in lieu of standard 20.5	-556	-370	-926
14.00 tires in lieu of standard 20.5	-1,349	-899	-2,248

Reflects weight with superstructure facing forward.

* Auxiliary hoist is considered as part of the counterweight. Please see counterweight configuration sheet for build-up.

GMK5120B Trailing Boom Proposal

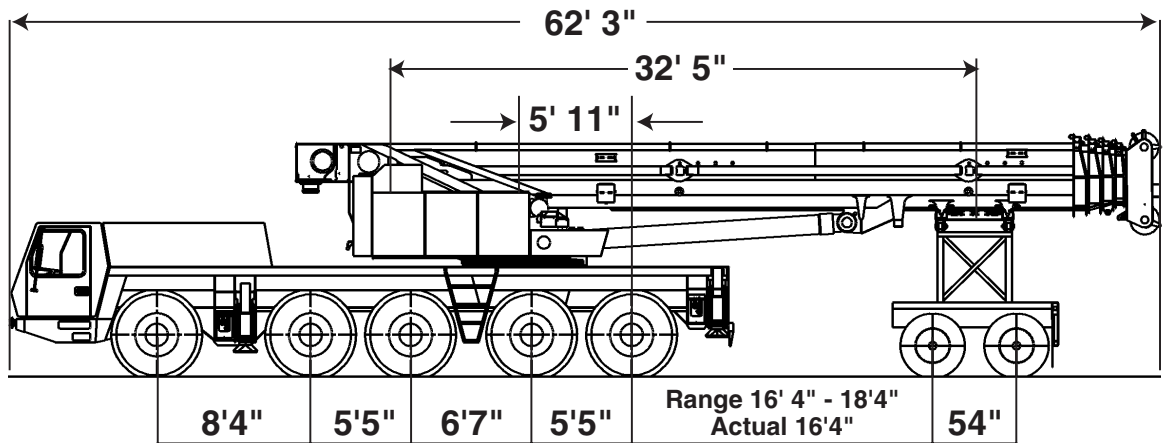

Boom Extended 0 Feet

Front 3 Axles
63,825 lbs.

Rear 2 Axles
30,741 lbs.

Dolly Axles
28,549 lbs.

G.V.W.
123,115 lbs.

Unit configured as follows:

- 42 – 167 ft. Boom
- 3MT counterweight on superstructure or carrier deck
- 20.5 tires
- 10 x 8 x 10 Drive
- Outrigger pads on machine
- Main & auxilliary hoists with wire rope
- 39 – 59 ft. hydraulically offsettable swingaway
- Additional oil cooler
- 2-Axle boom dolly (5,700 lbs.)

Weights may vary due to manufacturing tolerances

THIS ILLUSTRATION IS ONLY A GUIDE. CONSULT FACTORY FOR SPECIFIC DETAILS.

Superstructure Specifications

Boom

42 ft. - 167 ft. (12.8 m - 51 m) five section, full power MEGAFORM™ boom with patented TWIN-LOCK™ boom pinning system. Maximum tip height: 177 ft. (54 m).

Boom Elevation

Single lift cylinder with safety valve provides boom angle from -3° to +83°.

Lattice Jib Extension

Two 26 ft. (8 m) inserts for use with lattice swingaway extension to increase length up to 85 ft. (26 m) or 112 ft. (34 m).

Hydraulic Offsettable Lattice Swingaway

36 ft. - 59 ft. (11 m - 18 m) hydraulic offsettable lattice swingaway extension. Hydraulically offsettable 5°-40° with hydraulic luffing.

*Optional Lattice Extension

36 ft. - 59 ft. (11 m - 18 m) lattice swingaway extension offsettable at 0°, 20° and 40°.

Load Moment & Anti-Two Block System

Load moment and anti-two block system with audio/visual warning and control lever lockout provides electronic display of boom angle, length, radius, tip height, relative load moment, maximum permissible load, load indication and warning of impending two-block condition.

Cab

All aluminum construction cab is hydraulically tiltable (approximately 20°) and includes safety glass and adjustable operator's seat with hydraulic suspension. Other features include engine dependent hot water heater, armrest integrated crane controls, and ergonomically arranged instrumentation.

Swing

2 swing gears with axial piston fixed displacement motors provide swing speed of 0 - 1.7 RPM thru planetary gear box. Holding brake and service brake.

Counterweight

68,300 lbs. (31,000 kg) consisting of various sections with hydraulic installation/removal system.

Engine

Mercedes-Benz OM904LA, diesel, 4 cylinders, water cooled, turbocharged, 168 HP (125 kW) at 2300 rpm. Max. torque: 487 ft./lbs. (660 Nm) at 1200 rpm. Engine emission: EURO II/EUROMOT/EPA/CARB (non road).

Fuel Tank Capacity

53 gal. (200 L).

Hydraulic system

2 separate circuits, 1 axial piston variable displacement pump (load sensing) with electronic power limiting control and 1 gear pump for swing. Standard thermostatically controlled oil cooler keeps oil at optimum operating temperature. Tank capacity: 222 gal. (840 L)

Control system

Full electronic control of all crane movements is accomplished using electrical control levers with automatic reset to zero. Controls are integrated with the LMI and engine management system by CAN-BUS.

Hoist

Main and auxiliary hoist are powered by axial piston motor with planetary gear and brake. "Thumb-thumper" hoist drum rotation indicator alerts operator of hoist movement.

	Main	Auxiliary
Line length:	738 ft. (225 m)	591 ft. (180 m)
Rope diameter:	19 mm	19 mm
Line speed:	394 ft./min. (120 m)	394 ft./min. (120 m)
Line pull:	15,400 lbs. (70 kN)	15,400 lbs. (70 kN)

Electrical system

24 V system with three-phase alternator 28 V/80 A, 2 batteries 12 V/170 Ah.

* Optional equipment

- * Engine-independent hot water heater, with engine pre-heater
- * Second spotlight
- * Stereo/cassette player
- * Air Conditioning

Carrier Specifications

Chassis

Box-type, torsion resistant frame is fabricated from high-strength steel.

Outrigger System

Four hydraulic two-stage outrigger beams with vertical cylinders and outrigger pads. Outriggers can be set in two positions:

Fully extended (100%) - 24' 7" (7.5 m)

Partially extended (50%) - 16' 9" (5.1 m)

Independent horizontal and vertical movement control on each side of carrier. Crane level indicators at each control station.

Engine

Mercedes-Benz OM502LA, diesel, 8 cylinders, water cooled, turbo charged, 469 HP (350 kW) at 1800 rpm. Max. torque: 1,696 ft./lbs. (2300 Nm) at 1080 rpm. Engine emission: EURO II/EUROMOT/EPA/CARB (non road).

Fuel Tank Capacity

106 gal. (400 L).

Transmission

Daimler Chrysler G 240-16 with EAS (Electronic Automatic Shifting), 16 forward and 2 reverse speeds. Single speed transfer case with inter-axle differential lock.

Drive/Steer

10 x 8 x 10

Axles

1st axle line - steer

2nd axle line - drive/steer

3rd axle line - drive/steer

4th axle line - drive/steer (off road only)

5th axle line - drive/steer

Drive axles with planetary hub reduction and center mounted gearing.

Suspension

GROVE GMK5120B features the Grove exclusive MEGATRAK™ suspension. This revolutionary design features an independent hydroneumatic system with hydraulic lockout acting on all wheels. The suspension can be raised 6-1/2" (170 mm) or lowered 5" (130 mm) both longitudinally and transversely and features an automatic leveling system for on-highway travel.

Tires

10 tires, 20.5 R25.

Steering

Dual circuit steering system is hydraulic power assisted with a transfer case mounted, ground driven, emergency steering pump. Axles 1, 2, 3 and 5 steer on highway. Separate steering of the 4th and 5th axle for all wheel steer and crab-steer is controlled by an electric rocker switch.

Brakes

A dual circuit air system operates on all wheels with a spring-applied, air released parking brake acting on axles 2, 3, 4 and 5. An air dryer is fitted to remove moisture from the air system.

Anti-lock braking system (ABS).

Auxiliary exhaust brake and constant throttle brake is standard.

Cab

Two-man, aluminum construction driver's cab with thru access, includes the following features: safety glass; driver and passenger seats with hydraulic suspension, engine-dependent hot water heater, complete instrumentation and driving controls.

Electrical system

24 V system with three-phase alternator 28 V/100 A, 2 batteries 12 V/170 Ah.

Maximum Speed

53 mph (85 km/h) with 20.5 R25 tires.

Gradeability (Theoretical)

63% with 20.5 R25 tires.

Miscellaneous standard equipment

Trailing boom kit (less dolly); additional hydraulic oil cooler; spare tire and wheel - 20.5 R25 with carry bracket; flashing amber warning light on carrier cab; working light; tool kit; fire extinguisher; rooster sheave; radio cassette in carrier cab.

* Optional equipment

- * 10 x 6 x 10 drive/steer
- * Electric driveline retarder
- * 16.00 R25 tires (vehicle width 9 ft. 10 in. [3 m])
- * 14.00 R25 tires (vehicle width 9 ft. [2.75 m])
- * Engine-independent hot water heater, with engine pre-heater
- * Trailing boom "boost" weight transfer kit
- * Air conditioning

* Denotes optional equipment

Working Range



42 - 167 ft.
(12.8 - 51 m)



36 - 112 ft.
(11 - 34 m)



100%



360°

FEET

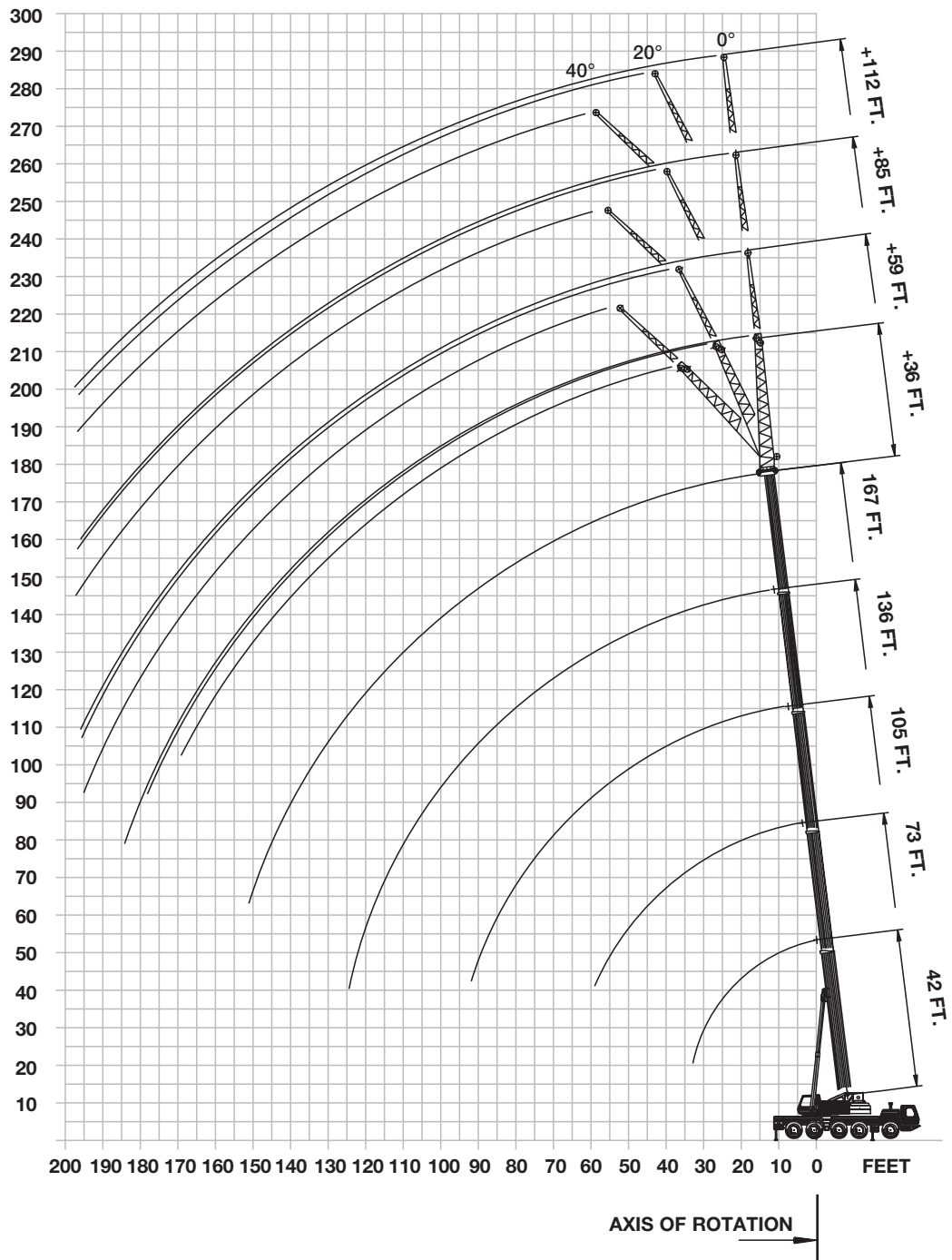

 42 - 167 ft.
 (12.8 - 51.0 m)
  68,300 lbs.
 (31,000 kg)
  100%
 24'7" Spread
  360°

Feet	Pounds (thousands)									
	42*	42	58	73	89	105	120	136	152	167
8	240.0									
9	228.0									
10	211.0	220.0	192.0	139.0						
15	168.0	168.0	161.0	139.0	121.0	90.0				
20	138.0	138.0	134.0	129.0	121.0	90.0	63.0	47.0		
25	114.0	114.0	114.0	110.0	108.0	88.0	63.0	47.0	35.8	
30	88.0	88.0	98.0	95.0	94.0	80.0	60.0	47.0	35.8	29.6
35			81.0	80.0	82.0	73.0	55.0	46.0	35.8	29.6
40			67.0	67.0	66.0	66.0	49.0	43.6	35.6	29.6
45			57.0	56.0	55.0	57.0	44.0	40.6	35.2	29.6
50				47.0	49.0	48.0	40.4	36.6	33.0	29.0
55				40.8	42.6	41.8	36.8	33.4	30.6	28.4
60					37.2	36.4	34.0	30.8	28.6	26.8
65					32.8	32.0	31.0	28.2	26.4	25.0
70					29.2	28.4	29.0	25.8	24.2	23.4
75					26.0	25.2	26.6	23.8	22.4	21.8
80						23.0	23.8	21.6	21.0	20.4
85						21.8	21.4	20.2	19.6	18.8
90						20.2	19.4	18.8	17.8	17.4
95							17.4	17.8	16.0	15.8
100							15.8	16.4	14.6	14.6
105								15.0	14.0	13.8
110								13.6	13.4	12.6
115								12.4	12.4	11.4
120								11.2	11.2	10.4
125									10.2	9.4
130									9.4	8.4
135									8.6	7.6
140										6.8
145										6.0
150										5.4

* Over rear only.
 Lifting capacities greater than 210,000 lbs require additional equipment.
 Note: Above chart is available with reduced outriggers.

 42 - 167 ft.
 (12.8 - 51.0 m)
  24,200 lbs.
 (11,000 kg)
  100%
 24'7" Spread
  360°

Feet	Pounds (thousands)									
	42*	42	58	73	89	105	120	136	152	167
8	240.0									
9	228.0									
10	211.0	220.0	192.0	139.0						
15	168.0	168.0	161.0	139.0	121.0	90.0				
20	138.0	132.0	126.0	114.0	107.0	90.0	63.0	47.0		
25	93.0	93.0	93.0	87.0	83.0	77.0	63.0	47.0	35.8	
30	65.0	65.0	69.0	67.0	66.0	61.0	56.0	47.0	35.8	29.6
35			53.0	55.0	53.0	49.0	49.0	44.0	35.8	29.6
40			42.2	43.6	43.6	41.0	41.2	38.8	35.6	29.6
45			34.4	35.8	35.8	37.4	34.8	33.4	30.0	29.6
50				30.2	30.0	31.4	29.6	29.4	28.2	25.8
55				25.4	27.2	26.8	26.0	25.8	24.4	22.2
60					23.2	22.8	23.4	22.4	21.2	19.2
65					20.0	20.0	20.2	19.6	18.6	16.6
70					17.2	17.4	17.6	16.8	16.2	14.4
75					15.0	15.0	15.2	14.6	14.2	12.6
80						13.0	13.4	12.6	12.4	11.0
85						11.4	11.6	11.0	10.6	9.4
90						10.0	10.2	9.6	9.2	8.2
95							8.8	8.2	8.0	7.0
100							7.8	7.2	6.8	5.8
105								6.2	5.8	4.8
110								5.2	5.0	4.0
115								4.4	4.2	3.2
120								3.6	3.4	2.4
125									2.8	
130									2.0	

* Over rear only.
 Lifting capacities greater than 210,000 lbs require additional equipment.
 Note: Above chart is available with reduced outriggers.

 42 - 167 ft.
 (12.8 - 51.0 m)
  15,400 lbs.
 (7,000 kg)
  100%
 24'7" Spread
  360°

Feet	Pounds (thousands)									
	42*	42	58	73	89	105	120	136	152	167
8	240.0									
9	228.0									
10	211.0	219.0	192.0	139.0						
15	168.0	167.0	161.0	139.0	121.0	90.0				
20	123.0	123.0	114.0	104.0	94.0	90.0	63.0	47.0		
25	81.0	81.0	81.0	76.0	74.0	68.0	62.0	47.0	35.8	
30	57.0	57.0	61.0	61.0	57.0	53.0	52.0	46.0	35.8	29.6
35			46.0	48.0	46.0	45.0	42.2	39.8	35.8	29.6
40			36.4	38.2	37.4	37.8	34.6	34.2	29.4	29.6
45			29.0	31.0	32.6	31.6	30.8	28.8	27.2	24.8
50				25.4	27.0	26.6	26.4	24.6	23.0	21.0
55				20.8	22.6	22.8	22.6	21.0	19.8	17.8
60					19.2	19.2	19.4	18.0	17.0	15.0
65					16.2	16.2	16.4	15.6	14.6	12.8
70					13.8	14.0	14.2	13.4	12.6	11.0
75					11.8	11.8	12.0	11.4	10.8	9.2
80						10.2	10.4	9.8	9.4	7.8
85						8.6	9.0	8.4	8.0	6.4
90						7.4	7.6	7.0	6.8	5.4
95							6.4	6.0	5.6	4.4
100							5.4	5.0	4.6	3.4
105								4.0	3.8	2.6
110								3.2	3.0	
115								2.4	2.2	

* Over rear only.
 Lifting capacities greater than 210,000 lbs require additional equipment.
 Note: Above chart is available with reduced outriggers.

THIS CHART IS ONLY A GUIDE AND SHOULD NOT BE USED TO OPERATE THE CRANE.
 The individual crane's load chart, operating instructions and other instructional plates must be read and understood prior to operating the crane.

 42 - 167 ft.
 (12.8 - 51.0 m)
  8,800 lbs.
 (4,000 kg)
  100%
 24'7" Spread
  360°

Feet	Pounds (thousands)									
	42	58	73	89	105	120	136	152	167	
10	218.0	192.0	139.0							
15	165.0	144.0	122.0	110.0	90.0					
20	104.0	94.0	85.0	80.0	72.0	63.0	47.0			
25	74.0	70.0	66.0	61.0	56.0	49.0	45.0	35.8		
30	51.0	54.0	51.0	47.0	46.0	41.8	40.0	34.0	29.6	
35		41.8	40.8	40.0	37.0	35.6	32.6	29.2	27.2	
40		32.0	33.0	32.8	30.4	29.4	27.0	25.2	22.4	
45		25.0	27.2	27.6	26.0	24.8	22.8	21.0	18.6	
50			22.0	23.2	22.0	21.0	19.2	17.8	15.6	
55			17.8	19.6	18.8	18.0	16.4	15.0	13.0	
60				16.4	16.0	15.4	14.0	12.8	10.8	
65				13.8	13.8	13.4	12.0	10.8	9.0	
70				11.6	11.6	11.4	10.2	9.2	7.4	
75				9.8	9.8	10.0	8.6	7.8	6.0	
80					8.2	8.4	7.4	6.6	4.8	
85					7.0	7.2	6.2	5.4	3.8	
90					5.8	6.0	5.2	4.4	2.8	
95						5.0	4.2	3.4		
100							3.4	2.6		
105								2.6		



Lifting capacities greater than 210,000 lbs require additional equipment.
 Note: Above chart is available with reduced outriggers.

 42 - 167 ft.
 (12.8 - 51.0 m)
  2,200 lbs.
 (1,000 kg)
  100%
 24'7" Spread
  360°

Feet	Pounds (thousands)									
	42	58	73	89	105	120	136	152	167	
10	216.0	192.0	139.0							
15	156.0	130.0	116.0	105.0	90.0					
20	94.0	87.0	80.0	73.0	65.0	59.0	47.0			
25	66.0	63.0	59.0	54.0	52.0	47.0	43.8	35.8		
30	45.0	47.0	45.0	43.8	40.0	38.2	34.8	29.2	28.6	
35		36.0	35.2	35.0	32.6	30.8	28.2	26.0	23.2	
40		27.6	28.4	28.4	26.6	25.4	23.2	21.2	18.8	
45		21.2	23.2	23.6	22.2	21.2	19.2	17.6	15.4	
50			18.6	19.8	18.6	17.8	16.0	14.6	12.6	
55			14.8	16.6	15.6	15.0	13.4	12.2	10.2	
60				13.8	13.2	12.8	11.2	10.2	8.2	
65				11.4	11.2	10.8	9.4	8.4	6.6	
70				9.4	9.4	9.0	7.8	6.8	5.0	
75				7.8	7.8	7.6	6.4	5.4	3.8	
80					6.4	6.4	5.2	4.2	2.6	
85					5.0	5.2	4.0	3.2		
90					4.0	4.2	3.0	2.4		
95						3.2	2.2			
100							2.4			

Lifting capacities greater than 210,000 lbs require additional equipment.
 Note: Above chart is available with reduced outriggers.

Hydraulic Offsettable Swingaway

 167 ft.
 (51.0 m)
  68,300 lbs.
 (31,000 kg)
  100%
 24'7" Spread
  360°

Feet	Pounds (thousands)									
	36 FT 20°		40°		59 FT 20°		85 FT 20°		112 FT 20°	
	5°	40°	5°	40°	5°	40°	5°	40°	5°	40°
30	17.4									
35	17.4									
40	17.4			11.6			7.8			
45	17.4	17.4		11.4			7.8			
50	17.4	17.4		11.4			7.8			
55	17.4	17.4	15.0	11.4			7.8			
60	17.4	17.4	14.8	11.2	10.4		7.8		4.8	
65	17.4	17.2	14.6	11.2	10.4		7.8		4.8	
70	17.0	16.6	14.4	11.2	10.2		7.8	7.8	4.8	4.8
75	16.4	15.8	14.2	11.0	10.2	8.2	7.8	7.8	4.8	4.8
80	15.8	15.2	13.8	11.0	10.2	8.0	7.8	7.8	7.4	4.8
85	15.2	14.4	13.6	10.8	10.0	7.8	7.8	7.8	7.4	4.8
90	14.4	13.8	13.4	10.8	10.0	7.8	7.8	7.8	7.4	4.8
95	13.4	13.2	13.0	10.8	9.8	7.6	7.8	7.8	7.4	4.8
100	12.6	12.6	12.4	10.6	9.8	7.6	7.8	7.8	7.2	4.8
105	12.0	12.0	12.0	10.4	9.6	7.4	7.8	7.8	7.2	4.8
110	11.4	11.4	11.4	10.0	9.6	7.4	7.8	7.8	7.2	4.8
115	10.8	10.8	10.8	9.6	9.2	7.2	7.8	7.6	7.0	4.8
120	10.2	10.2	10.2	9.2	9.0	7.2	7.6	7.4	7.0	4.8
125	9.4	9.4	9.4	8.8	8.6	7.2	7.2	7.2	6.8	4.8
130	8.6	8.8	8.8	8.4	8.4	7.0	7.0	6.8	6.6	4.8
135	7.6	8.2	8.4	8.0	8.0	7.0	6.6	6.6	6.6	4.8
140	6.8	7.4	7.8	7.8	7.6	7.0	6.4	6.2	6.2	4.8
145	6.2	6.6	7.0	7.2	7.4	6.8	6.0	6.0	6.0	4.8
150	5.6	5.8	6.2	6.4	7.0	6.8	5.8	5.8	5.8	4.6
155	5.0	5.2	5.4	5.8	6.4	6.6	5.6	5.6	5.6	4.4
160	4.4	4.6		5.2	5.8	6.2	5.2	5.2	5.2	4.2
165	3.8	4.0		4.6	5.2	5.6	4.6	5.0	5.0	4.0
170	3.4	3.6		4.2	4.6	5.0	4.0	4.6	4.8	3.8
175	2.8	3.0		3.6	4.2	4.4	3.6	4.2	4.6	3.6
180	2.4	2.6		3.2	3.6		3.2	3.6	4.2	3.4
185	2.0			2.8	3.2		2.6	3.2	3.6	3.2
190	1.6			2.4	2.6		2.2	2.8	3.0	3.0
195				2.0	2.2		1.8	2.4	2.6	2.8
200					1.8		1.6	2.0	2.2	2.4
205										1.8

THIS CHART IS ONLY A GUIDE AND SHOULD NOT BE USED TO OPERATE THE CRANE.
 The individual crane's load chart, operating instructions and other instructional plates must be read and understood prior to operating the crane.

167 ft. (51.0 m)		36-59-85-112 ft. (11-18-26-34 m)		68,300 lbs. (31,000 kg)		100% 24'7" Spread		360°	
Pounds (thousands)									
Feet	36 FT		59 FT		85 FT		112 FT		
	5°-20°	20°-40°	5°-20°	20°-40°	5°-20°	20°-40°	5°-20°	20°-40°	
45	15.8								
50	15.8								
55	15.8	12.6							
60	15.8	12.4	9.4						
65	15.6	12.0	9.4						
70	15.0	11.8	9.4			7.2		4.4	
75	14.4	11.6	9.2	6.4		7.2		4.4	
80	13.8	11.4	9.2	6.2		7.2	6.4	4.4	
85	13.2	11.0	9.2	6.2		7.2	6.2	4.4	
90	12.6	10.8	9.0	6.0		7.2	6.2	4.4	4.0
95	12.0	10.6	9.0	5.8		7.2	6.0	4.4	4.0
100	11.4	10.4	9.0	5.8		7.2	5.8	4.4	4.0
105	10.8	10.4	8.8	5.6		7.2	5.8	4.4	4.0
110	10.4	10.2	8.6	5.6		7.0	5.6	4.4	4.0
115	9.8	9.8	8.2	5.4		7.0	5.6	4.4	4.0
120	9.2	9.2	8.0	5.4		6.8	5.4	4.4	4.0
125	8.6	8.6	7.8	5.2		6.4	5.4	4.4	3.8
130	7.8	8.0	7.6	5.2		6.2	5.4	4.4	3.8
135	7.0	7.4	7.2	5.0		6.0	5.2	4.4	3.8
140	6.2	6.6	7.0	5.0		5.8	5.2	4.2	3.8
145	5.6	6.0	6.4	5.0		5.4	5.2	4.2	3.8
150	5.0	5.4	5.8	5.0		5.2	5.0	4.0	3.8
155	4.4	4.8	5.2	4.8		5.2	5.0	4.0	3.8
160	4.0		4.8	4.8		4.6	4.8	3.8	3.6
165	3.4		4.2	4.8		4.2	4.6	3.6	3.6
170	3.0		3.8	4.2		3.8	4.2	3.4	3.4
175	2.6		3.4	3.8		3.2	3.8	3.2	3.2
180	2.2		2.8			2.8	3.4	2.8	3.0
185			2.6			2.4	2.8	2.4	2.8
190			2.2			2.0	2.4	2.0	2.4
195			1.8			1.8	2.2	1.6	2.2
200							1.8		1.8

167 ft. (51.0 m)		36-59-85-112 ft. (11-18-26-34 m)		24,200 lbs. (11,000 kg)		100% 24'7" Spread		360°	
Pounds (thousands)									
Feet	36 FT		59 FT		85 FT		112 FT		
	5°	40°	5°	40°	5°	40°	5°	40°	
30	17.4								
35	17.4								
40	17.4								
45	17.4	17.4		11.6		7.8		4.8	
50	17.4	17.4		11.4		7.8		4.8	
55	17.4	17.4	15.0	11.4		7.8		4.8	
60	17.4	17.4	14.8	11.2	10.4	7.8		4.8	
65	15.8	17.2	14.6	11.2	10.4	7.8		4.8	
70	13.6	15.0	14.4	11.2	10.2	7.8	7.8	4.8	4.8
75	11.8	13.0	14.2	11.0	10.2	8.2	7.8	7.8	4.8
80	10.2	11.4	12.8	11.0	10.2	8.0	7.8	7.8	4.8
85	8.8	10.0	11.2	9.8	10.0	7.8	7.8	7.4	4.8
90	7.6	8.6	9.6	8.6	10.0	7.8	7.8	7.4	4.8
95	6.4	7.4	8.4	7.4	9.0	7.6	7.8	7.4	4.8
100	5.4	6.4	7.2	6.4	7.8	7.6	6.0	7.6	4.8
105	4.6	5.4	6.2	5.6	6.8	7.4	5.2	6.6	4.8
110	3.8	4.4	5.2	4.6	6.0	7.2	4.4	5.6	4.8
115	3.0	3.6	4.4	4.0	5.0	6.4	3.6	4.8	4.8
120	2.2	3.0	3.6	3.2	4.2	5.4	3.0	4.0	4.4
125	1.6	2.2	2.8	2.6	3.6	4.6	2.2	3.4	4.2
130		1.6	2.2	2.0	3.0	4.0	1.6	2.6	3.8
135			2.2	2.2	3.2	3.2		2.0	3.2
140				1.8	2.6	2.6		1.6	2.4
145					2.0	2.0		1.8	1.8

167 ft. (51.0 m)		36-59-85-112 ft. (11-18-26-34 m)		24,200 lbs. (11,000 kg)		100% 24'7" Spread		360°	
Pounds (thousands)									
Feet	36 FT		59 FT		85 FT		112 FT		
	5°-20°	20°-40°	5°-20°	20°-40°	5°-20°	20°-40°	5°-20°	20°-40°	
45	15.8								
50	15.8								
55	15.8	12.6							
60	15.8	12.4	9.4						
65	14.4	12.0	9.4						
70	12.4	11.8	9.4			7.2		4.4	
75	10.8	11.6	9.2	6.4		7.2		4.4	
80	9.4	10.4	9.2	6.2		7.2	6.4	4.4	
85	8.0	9.0	9.0	6.2		7.2	6.2	4.4	
90	7.0	7.8	7.8	6.0		7.2	6.2	4.4	4.0
95	6.0	6.8	6.8	5.8		6.4	6.0	4.4	4.0
100	5.0	5.8	5.8	5.8		5.6	5.8	4.4	4.0
105	4.2	4.8	5.0	5.6		4.8	5.8	4.4	4.0
110	3.4	4.0	4.2	5.4		4.0	5.2	3.6	4.0
115	2.8	3.4	3.6	4.6		3.2	4.4	3.0	4.0
120	2.0	2.6	3.0	3.8		2.6	3.6	2.4	3.4
125		2.0	2.4	3.2		2.0	3.0	1.8	2.8
130			1.8	2.6		1.6	2.4		2.2
135				2.0			2.0		1.6
140				1.6					1.6

THIS CHART IS ONLY A GUIDE AND SHOULD NOT BE USED TO OPERATE THE CRANE.
The individual crane's load chart, operating instructions and other instructional plates must be read and understood prior to operating the crane.

		36 FT		59 FT			
		5°	20°	40°	5°	20°	40°
30	17.4						
35	17.4						
40	17.4				11.6		
45	17.4	17.4			11.4		
50	17.4	17.4			11.4		
55	16.6	17.4	15.0		11.4		
60	14.2	15.8	14.8			10.4	
65	12.0	13.6	14.6		11.2	10.4	
70	10.2	11.6	13.2		11.2	10.2	
75	8.6	9.8	11.2		9.6	10.2	8.2
80	7.2	8.4	9.6		8.2	10.0	8.0
85	6.0	7.0	8.2		7.0	8.8	7.8
90	5.0	5.8	7.0		6.0	7.6	7.8
95	4.0	4.8	5.8		5.0	6.4	7.6
100	3.0	3.8	4.8		4.0	5.4	7.0
105	2.2	3.0	3.8		3.2	4.6	6.0
110	1.6	2.2	3.0		2.4	3.8	5.0
115		1.6	2.2		1.8	3.0	4.2
120						2.2	3.4
125						1.6	2.8
130							2.0

		36 FT		59 FT	
		5°-20°	20°-40°	5°-20°	20°-40°
45	15.8				
50	15.8				
55	15.2		12.6		
60	13.0		12.4	9.4	
65	11.0		12.0	9.4	
70	9.4		10.6	9.4	
75	7.8		9.0	8.8	6.4
80	6.6		7.6	7.4	6.2
85	5.4		6.4	6.4	6.2
90	4.4		5.4	5.4	6.0
95	3.6		4.4	4.4	5.8
100	2.8		3.6	3.6	5.0
105	2.0		2.8	3.0	4.2
110			2.0	2.2	3.4
115				1.6	2.6
120					2.0

Fixed Offsettable Swingaway

		36 FT		59 FT		85 FT		112 FT	
		0°	40°	0°	40°	0°	40°	0°	40°
30	17.6								
35	17.6			11.4					
40	17.6			11.4		7.8		4.8	
45	17.6	18.0		11.4		7.8		4.8	
50	17.6	18.0		11.4		7.8		4.8	
55	17.6	18.0	15.8	11.4		7.8		4.8	
60	17.6	17.6	15.6	11.4	10.4	7.8		4.8	
65	17.6	17.2	15.2	11.4	10.4	7.8		4.8	
70	17.6	16.6	15.0	11.2	10.2	7.8	8.6	4.8	5.4
75	17.2	15.8	14.6	11.2	10.2	8.8	7.8	8.6	5.4
80	16.4	15.2	14.2	11.2	10.0	8.8	7.8	8.4	7.4
85	15.4	14.4	13.8	11.0	10.0	8.6	7.8	8.4	7.4
90	14.4	13.8	13.4	11.0	9.8	8.6	7.8	8.2	7.4
95	13.4	13.2	13.0	11.0	9.6	8.4	7.8	8.2	7.4
100	12.6	12.6	12.4	10.8	9.4	8.4	7.8	8.0	7.2
105	12.0	12.0	12.0	10.6	9.2	8.4	7.8	7.8	7.2
110	11.4	11.4	11.4	10.2	9.0	8.2	7.8	7.8	7.2
115	10.8	10.8	11.0	9.8	8.8	8.2	7.8	7.6	7.0
120	10.0	10.2	10.6	9.4	8.6	8.2	7.6	7.4	7.0
125	9.4	9.6	10.0	9.0	8.4	8.0	7.2	7.2	6.8
130	8.6	9.0	9.4	8.6	8.2	8.0	7.0	6.8	6.6
135	7.8	8.4	8.8	8.2	8.0	7.8	6.6	6.6	6.6
140	7.0	7.6	8.0	7.8	7.6	7.6	6.4	6.2	6.4
145	6.4	6.8	7.2	7.2	7.4	7.4	6.0	6.0	6.2
150	5.6	6.2	6.4	6.4	7.0	7.2	5.8	6.0	6.0
155	5.0	5.4	5.8	5.8	6.6	7.0	5.4	5.6	5.8
160	4.4	4.8	5.8	5.2	6.0	6.6	5.2	5.2	5.6
165	4.0	4.2		4.6	5.4	5.8	4.6	5.0	5.4
170	3.4	3.8		4.2	4.8	5.2	4.2	4.8	5.0
175	3.0	3.2		3.8	4.4	4.6	3.6	4.4	4.8
180	2.4	2.8		3.2	3.8		3.2	4.0	4.4
185	2.0			2.8	3.4		2.8	3.4	3.8
190	1.6			2.4	2.8		2.4	3.0	3.4
195				2.0	2.4		2.0	2.6	2.8
200				1.6	2.0		1.6	2.2	2.4
205					1.6			1.8	2.2
210									1.8

THIS CHART IS ONLY A GUIDE AND SHOULD NOT BE USED TO OPERATE THE CRANE.
The individual crane's load chart, operating instructions and other instructional plates must be read and understood prior to operating the crane.

		36 FT		59 FT		85 FT		112 FT		
		0°	20°	40°	0°	20°	40°	0°	20°	40°
Feet										
30	17.6									
35	17.6				11.4					
40	17.6				11.4		7.8		4.8	
45	17.6	18.0			11.4		7.8		4.8	
50	17.6	18.0			11.4		7.8		4.8	
55	17.6	18.0	15.8		11.4		7.8		4.8	
60	17.6	17.6	15.6		11.4	10.4	7.8		4.8	
65	15.8	17.2	15.2		11.4	10.4	7.8		4.8	
70	13.8	15.4	15.0		11.2	10.2	7.8		4.8	
75	12.0	13.6	14.6		11.2	10.2	8.8		4.8	5.4
80	10.4	11.8	13.2		11.0	10.0	8.8	7.8	8.4	5.4
85	9.0	10.4	11.4		9.6	10.0	8.6	7.8	8.4	7.4
90	7.8	9.0	10.0		8.4	9.8	8.6	7.8	8.2	7.4
95	6.6	7.8	8.8		7.2	9.2	8.4	7.0	8.2	7.4
100	5.6	6.8	7.6		6.4	8.2	8.4	6.0	7.8	7.2
105	4.8	5.8	6.6		5.4	7.2	8.4	5.2	7.0	7.2
110	4.0	4.8	5.6		4.6	6.2	7.6	4.4	6.0	7.2
115	3.2	4.0	4.8		3.8	5.4	6.6	3.6	5.2	6.4
120	2.4	3.2	3.8		3.2	4.6	5.8	3.0	4.4	5.6
125	1.8	2.6	3.2		2.6	3.8	5.0	2.4	3.8	4.8
130		2.0	2.4		2.0	3.2	4.2	1.8	3.0	4.2
135			1.8			2.6	3.4		2.4	3.4
140						2.0	2.8		1.8	2.8
145							2.2			2.2
150							1.6			1.6

		36 FT		59 FT			
		0°	20°	40°	0°	20°	40°
Feet							
30	17.6						
35	17.6				11.4		
40	17.6				11.4		
45	17.6		18.0		11.4		
50	17.6		18.0		11.4		
55	16.6		18.0	15.8	11.4		
60	14.2		16.2	15.6	11.4		
65	12.0		14.0	15.2	11.4	10.4	
70	10.2		12.0	13.6	10.8	10.2	
75	8.8		10.4	11.6	9.4	10.2	8.8
80	7.4		8.8	10.0	8.0	10.0	8.8
85	6.2		7.4	8.6	6.8	9.0	8.6
90	5.0		6.4	7.4	5.8	7.8	8.6
95	4.0		5.2	6.2	4.8	6.8	8.4
100	3.2		4.2	5.2	4.0	5.8	7.4
105	2.4		3.4	4.2	3.2	4.8	6.2
110	1.6		2.6	3.4	2.4	4.0	5.4
115			2.0	2.6	1.8	3.2	4.4
120				1.8		2.6	3.8
125						2.0	3.0
130							2.4
135							1.6

Boom extension configurations

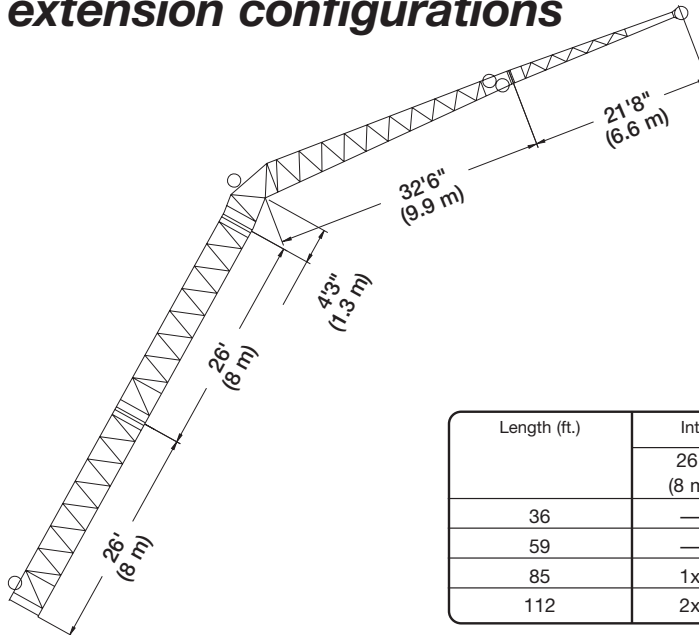

Length (ft.)	Intermediate section boom extension make-up			
	26' (8 m)	4'3" (1.3 m)	32'6" (9.9 m)	21'8" (6.6 m)
36	—	1x	1x	—
59	—	1x	1x	1x
85	1x	1x	1x	1x
112	2x	1x	1x	1x

THIS CHART IS ONLY A GUIDE AND SHOULD NOT BE USED TO OPERATE THE CRANE.
The individual crane's load chart, operating instructions and other instructional plates must be read and understood prior to operating the crane.

Rated Lifting Capacities

IMPORTANT NOTES:

WARNING: THIS CHART IS ONLY A GUIDE. The notes below are for illustration only and should not be relied upon to operate the crane. The individual crane's load chart, operating instructions and other instruction plates must be read and understood prior to operating the crane.

1. All rated loads meet ANSI/ASME B30.5, Mobile and Locomotive Cranes. Testing and development were performed to SAEJ1063, Cantilevered Boom Crane Structures - Method of Test and SAEJ765 Crane Stability Test Code.



















2. Capacities given do not include the weight of hook blocks, slings, auxiliary lifting equipment and load handling devices. Their weights must be added to the load to be lifted. When more than minimum required reeving is used, the additional rope weight shall be considered part of the load.

3. The machine shall be leveled on a firm supporting surface. Depending on the nature of the supporting surface, it may be necessary to have structural supports under the outrigger floats to spread the load to a larger bearing surface.

4. When either boom length or radius or both are between values listed, the smallest load shown at either the next larger radius or next longer or shorter boom length shall be used.

5. For outrigger operation, outriggers shall be properly extended with tires raised off the ground before operating the boom or lifting loads.

Symbols Glossary

	Frame		Steering
	Outriggers		Transmission
	Outrigger Controls		Axles
	Engine		Brakes
	Fuel Tank Capacity		Tires
	Electrical System		Suspension
	Drive		Rotation
	Lights		Boom Elevation
	Cab		Swing
	Boom		Counterweight
	Fixed Swingaway		Oil
	Tele-Swingaway		Hydraulic System
	Lattice Extension (Luffing)		Hoist
	Boom Nose		Radius
	Boom Extension		Boom Length
	Speed		Hookblock
	Grade		Gear
	Lattice Extension		Luffing Jib

GMK5120B Features and Benefits



▶ MEGATRAK™ is an independent suspension and all wheel steer system which allows all wheels to remain on the ground at all times so stresses and weight are not continually transferred between axles

▶ ECOS (Electronic Crane Operating System) is a computerized system that continuously monitors and controls principle crane functions as programmed by an operator



▶ EKS4 is an electronic load moment indicator that operates in conjunction with ECOS continuously displaying crane configuration and load moment data

▶ MEGAFORM™ is a "U" shape boom design which forms a natural cradle position for boom sections which eliminates stiffeners thus reducing weight and increasing capacity

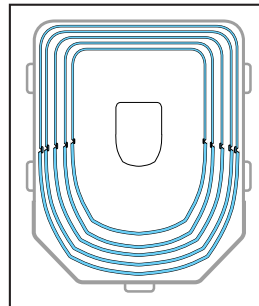

▶ TWIN-LOCK™ is a boom pinning mechanism that automatically pins the sections in position using two horizontal large diameter boom pins

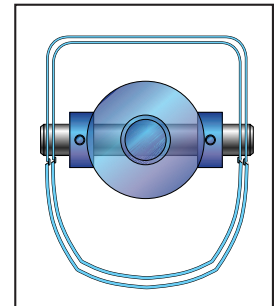

Constant improvement and engineering progress make it necessary that we reserve the right to make specification, equipment, and price changes without notice. Illustrations shown may include optional equipment and accessories and may not include all standard equipment.

GROVE® and GROVE LOGO are registered trademarks of GROVE in the U.S. and/or other countries. Copyright© 2000 GROVE. All rights reserved.

Grove Worldwide - World Headquarters

1565 Buchanan Trail East

P.O. Box 21

Shady Grove, Pennsylvania 17256-0021, U.S.A.

Tel: (717) 597-8121

Fax: (717) 597-4062

www.groveworldwide.com